

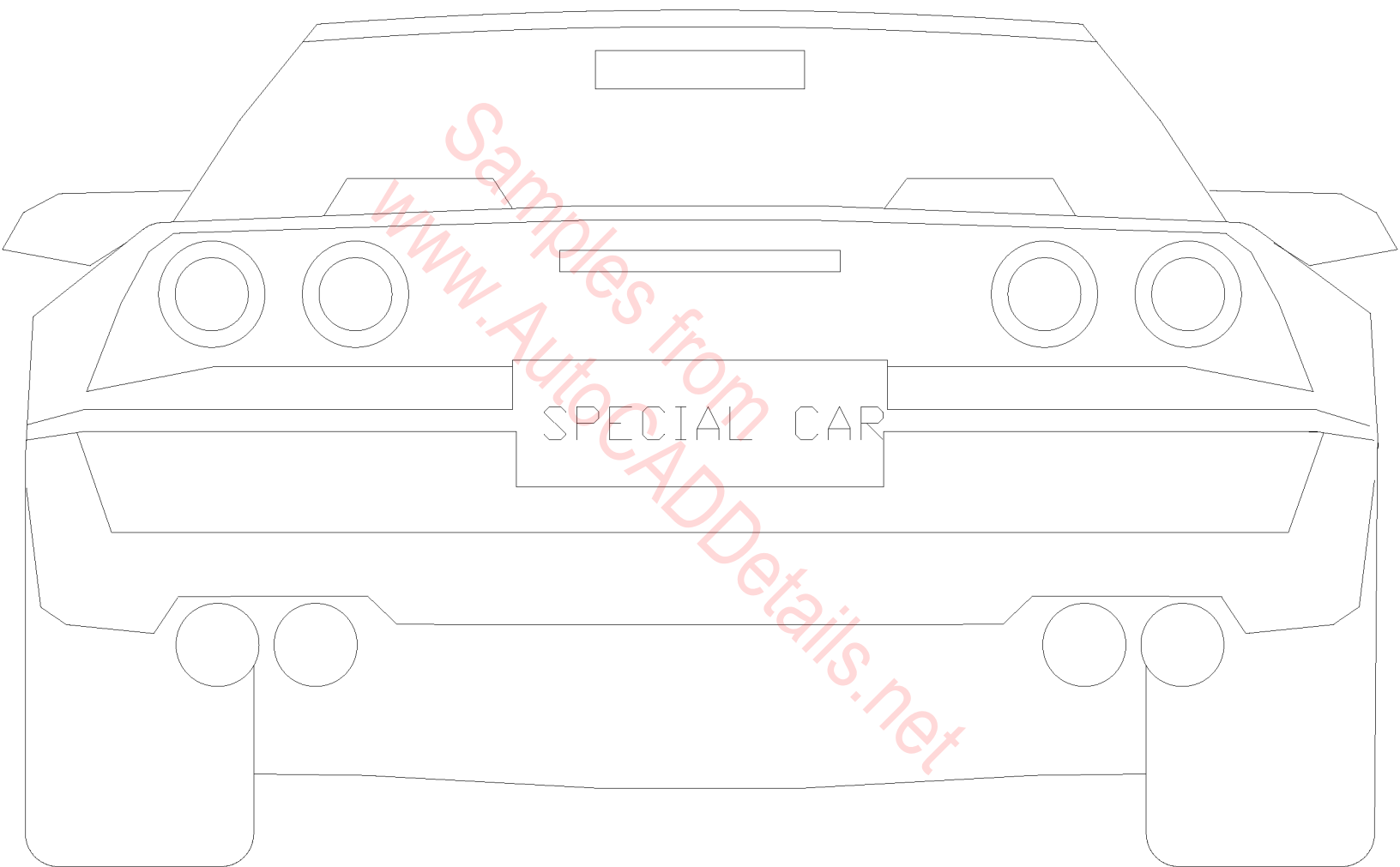

Samples from
www.AutoCADDetails.net

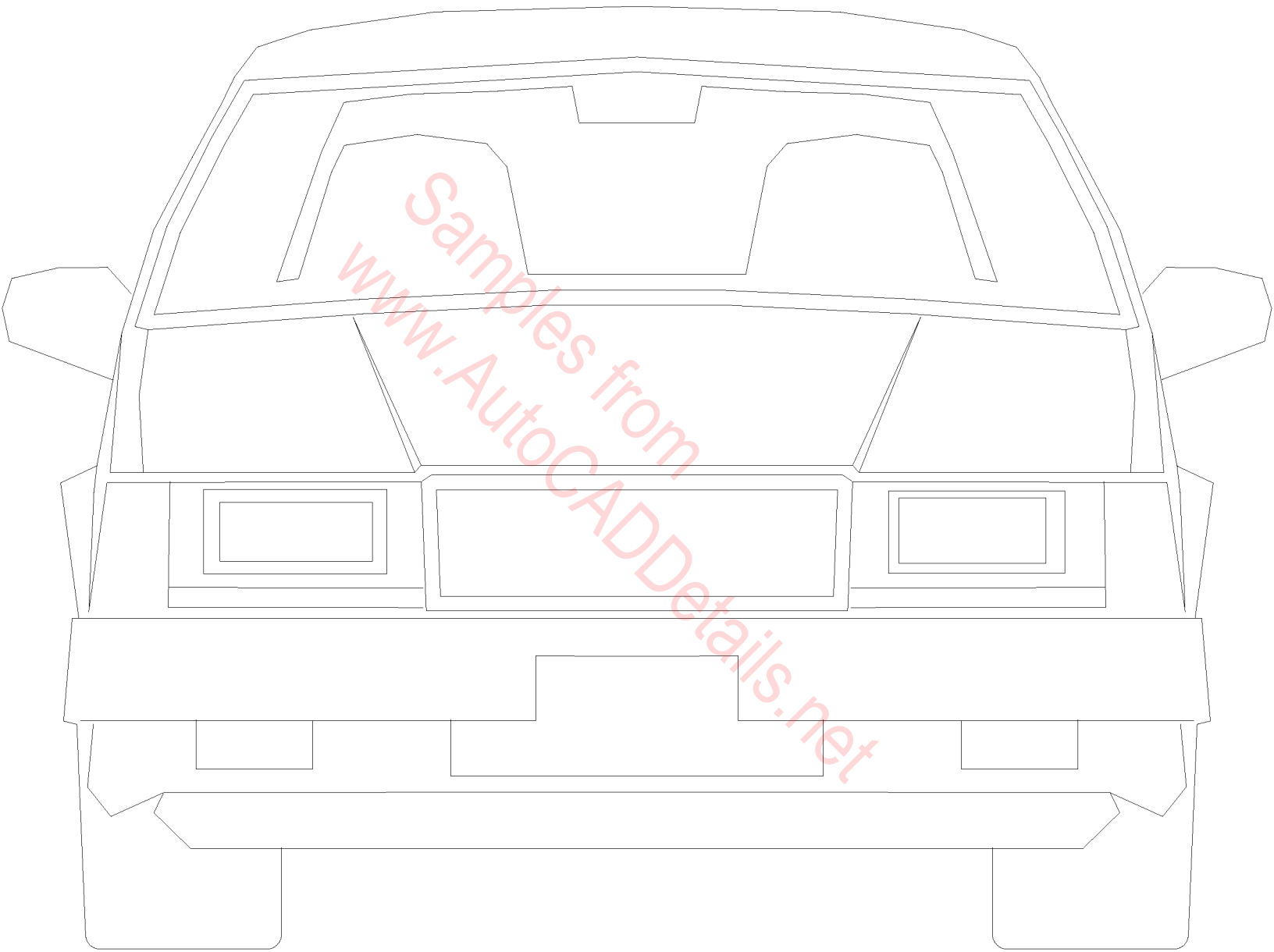

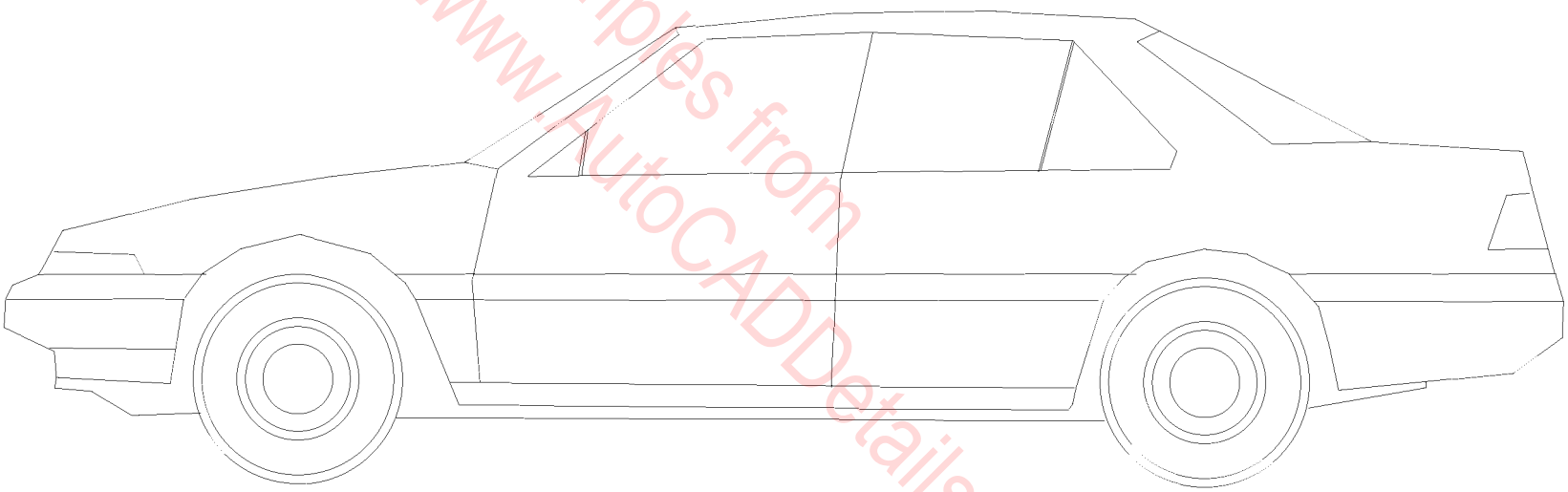



Samples from
www.AutoCADDetails.net

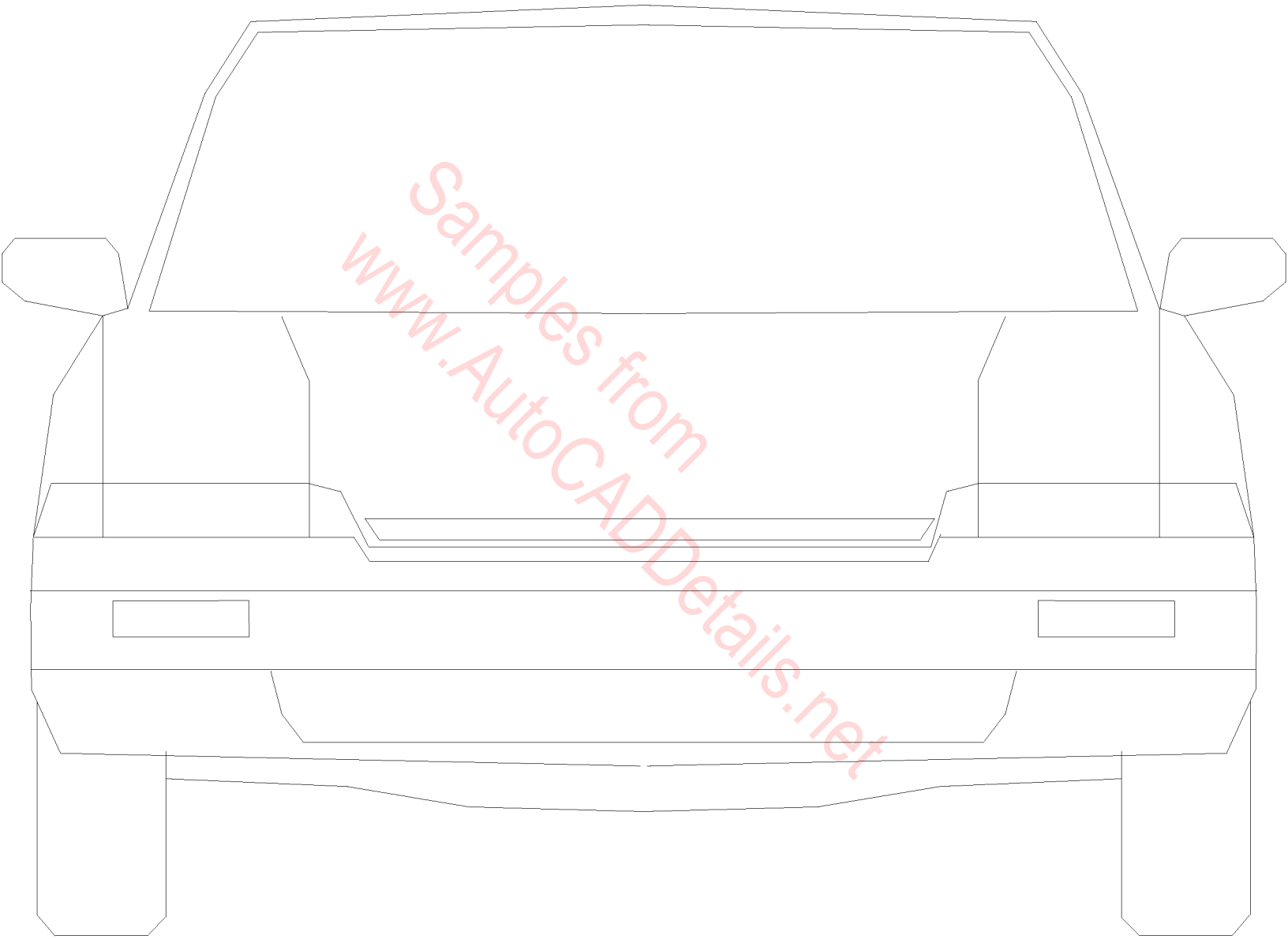

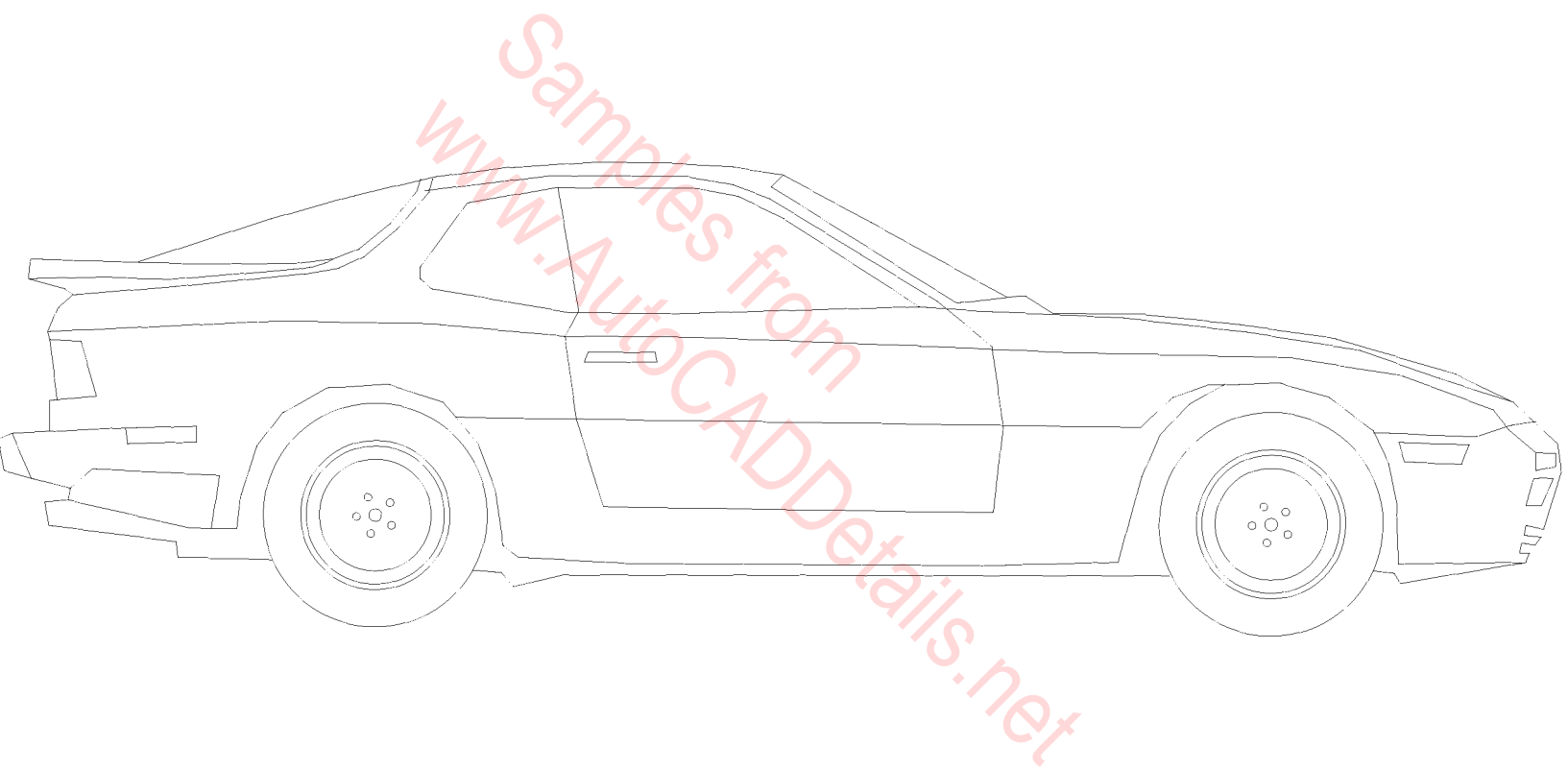

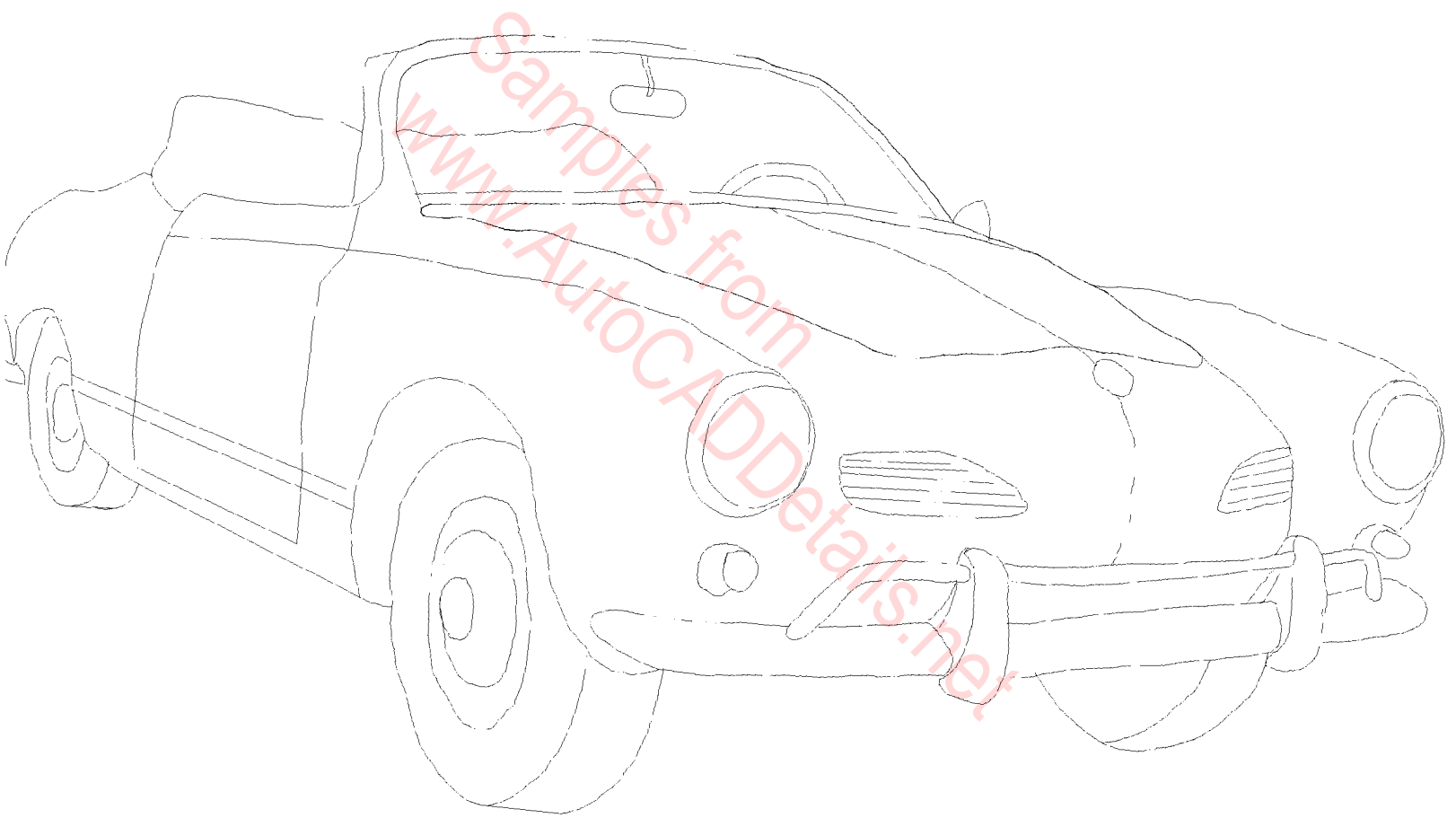

Samples from
www.AutoCADDetails.net

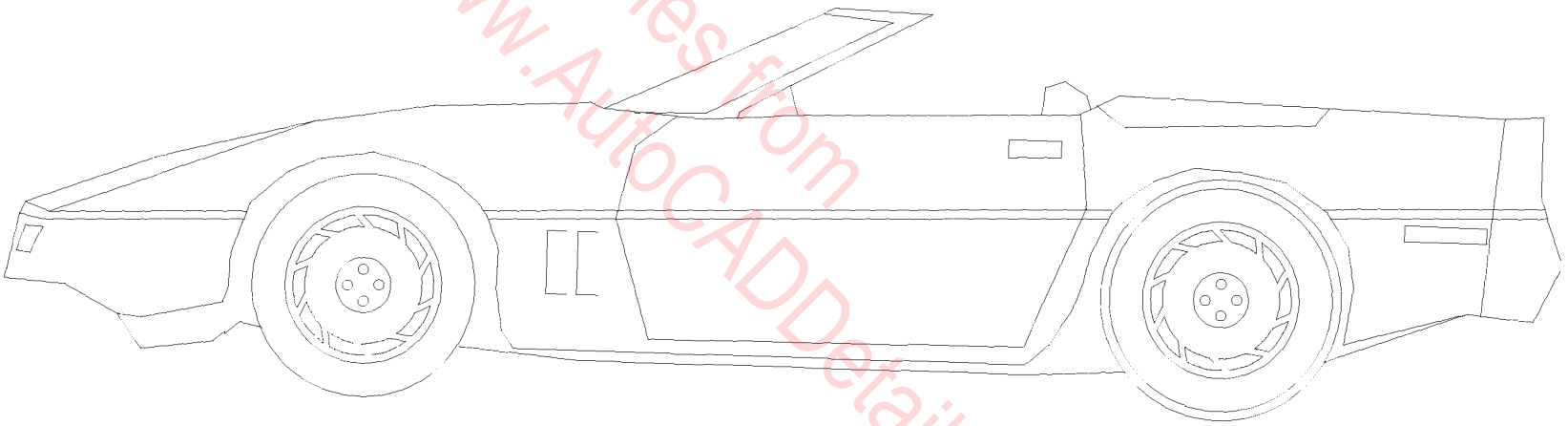

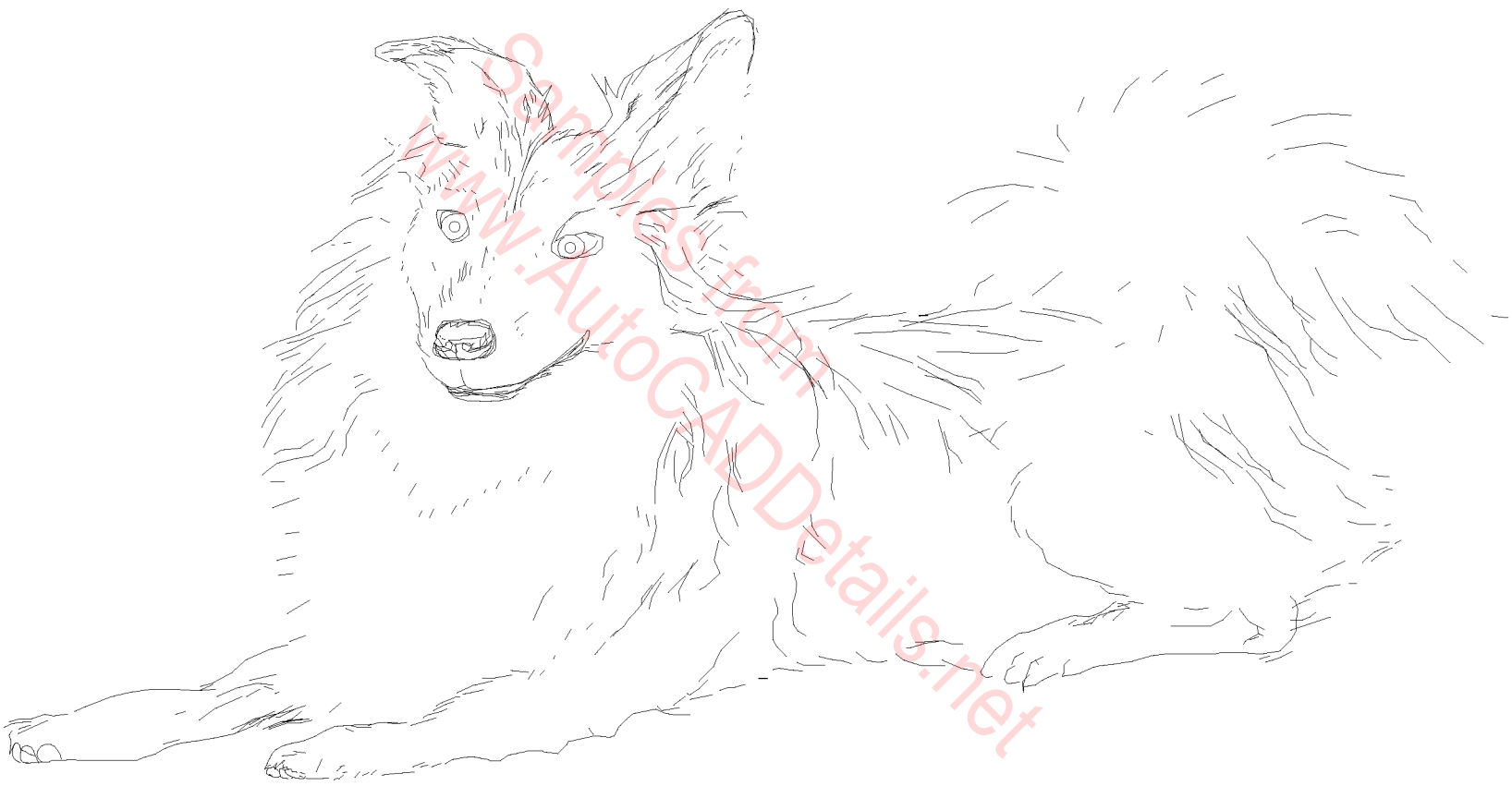

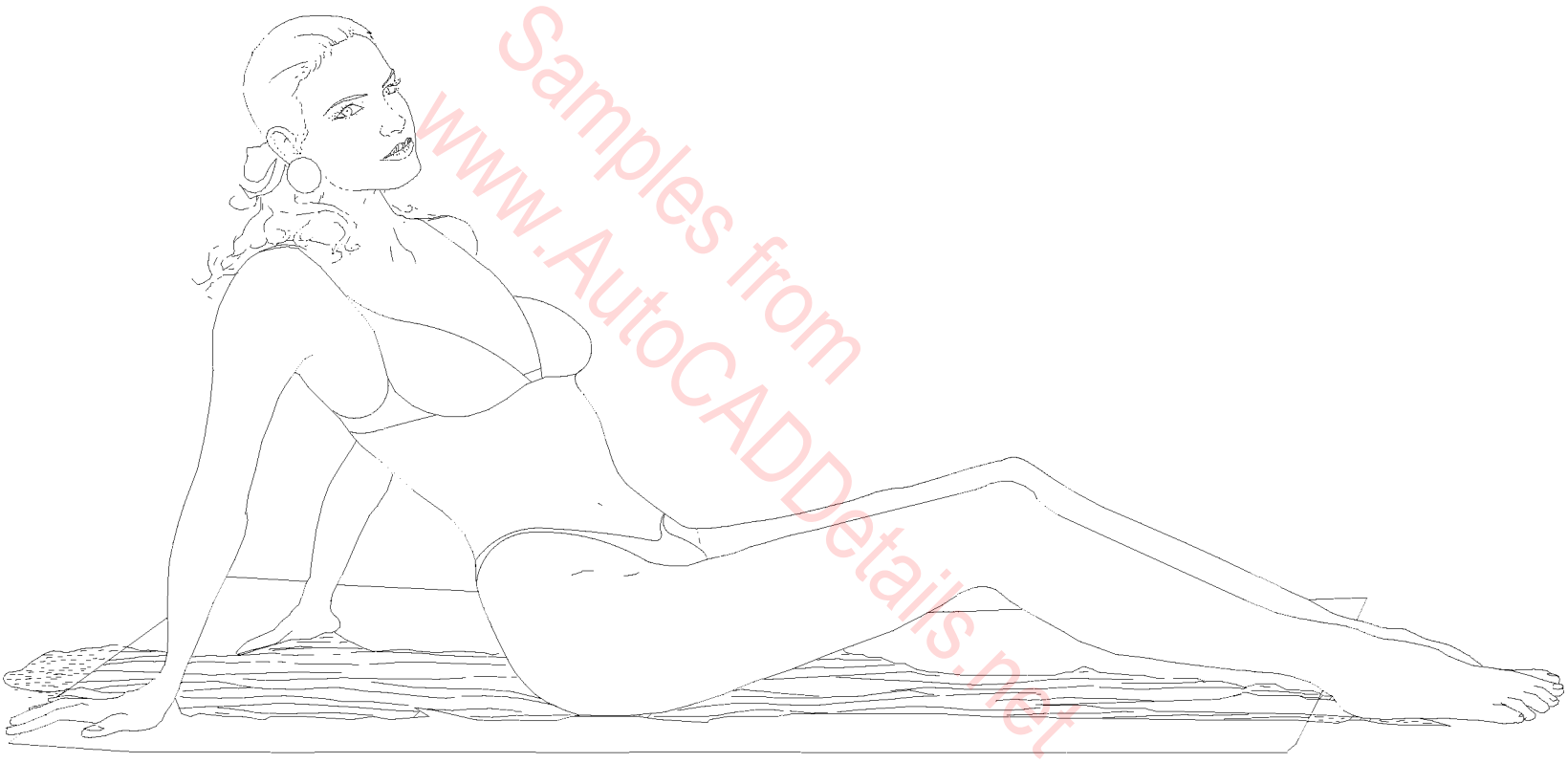

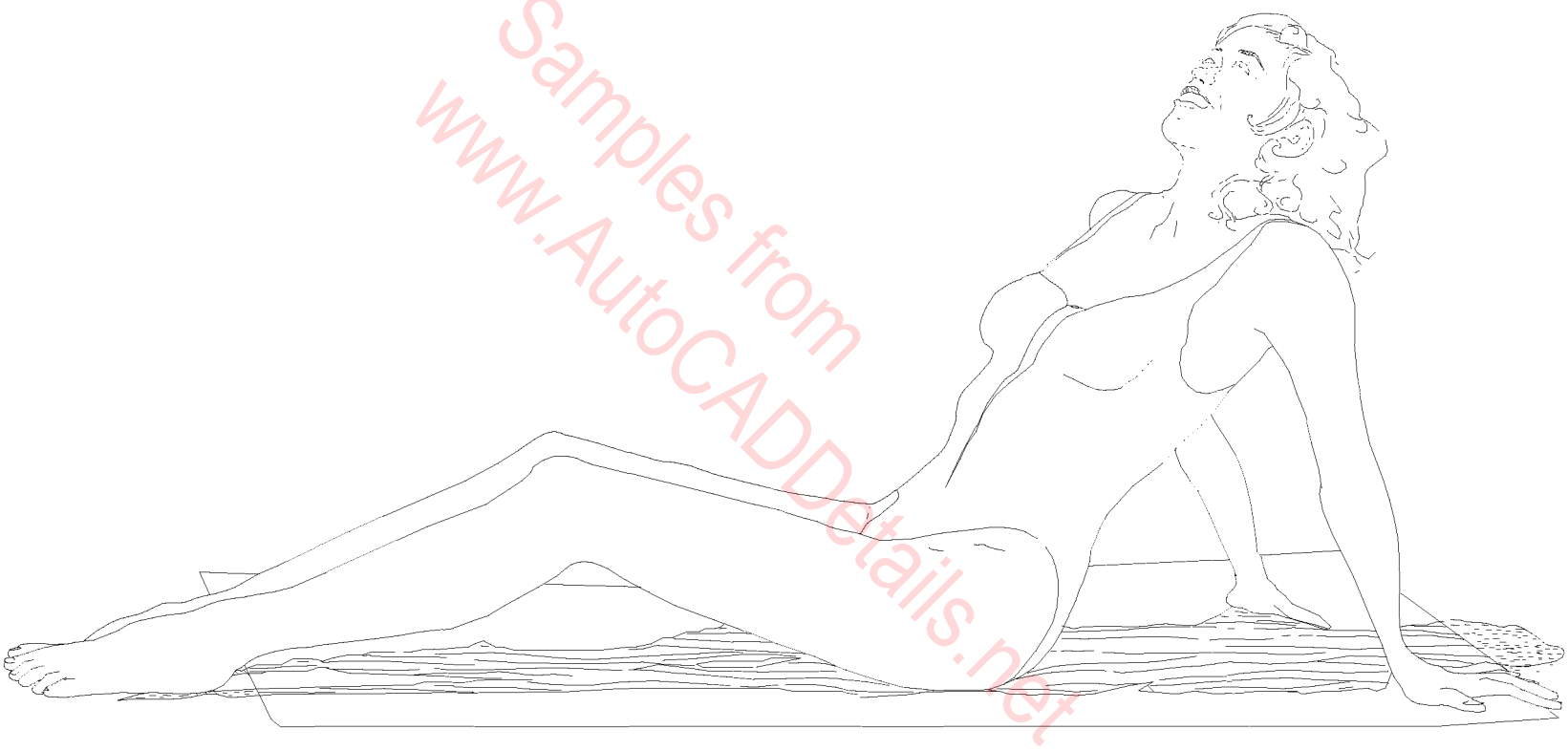

Samples from
www.AutoCADDetails.net



Samples from
www.AutoCADDetails.net

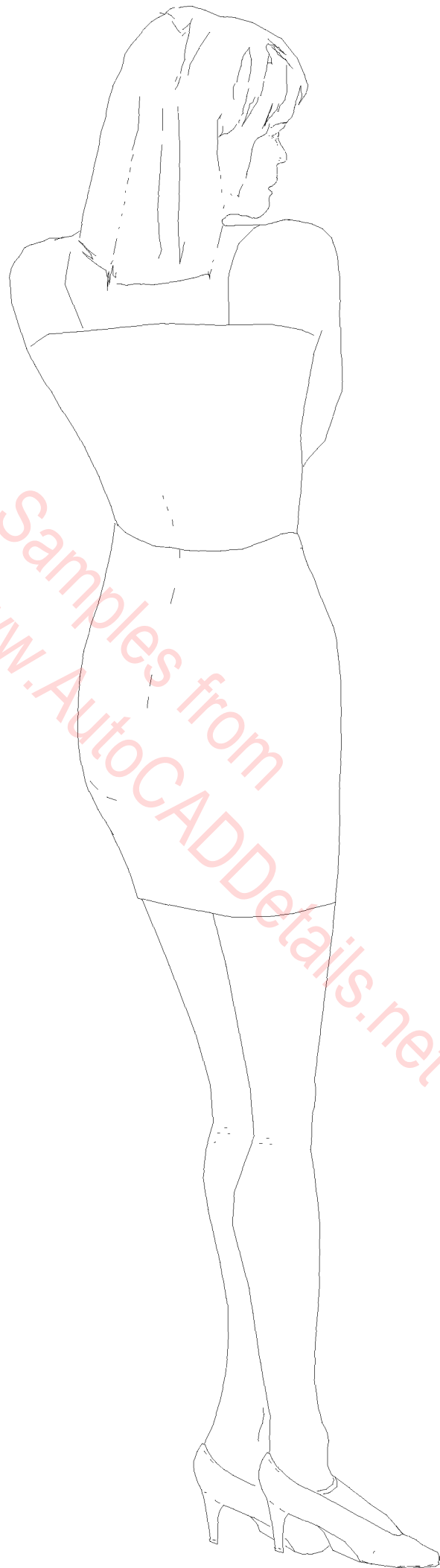





Samples from
www.AutoCADDetails.net

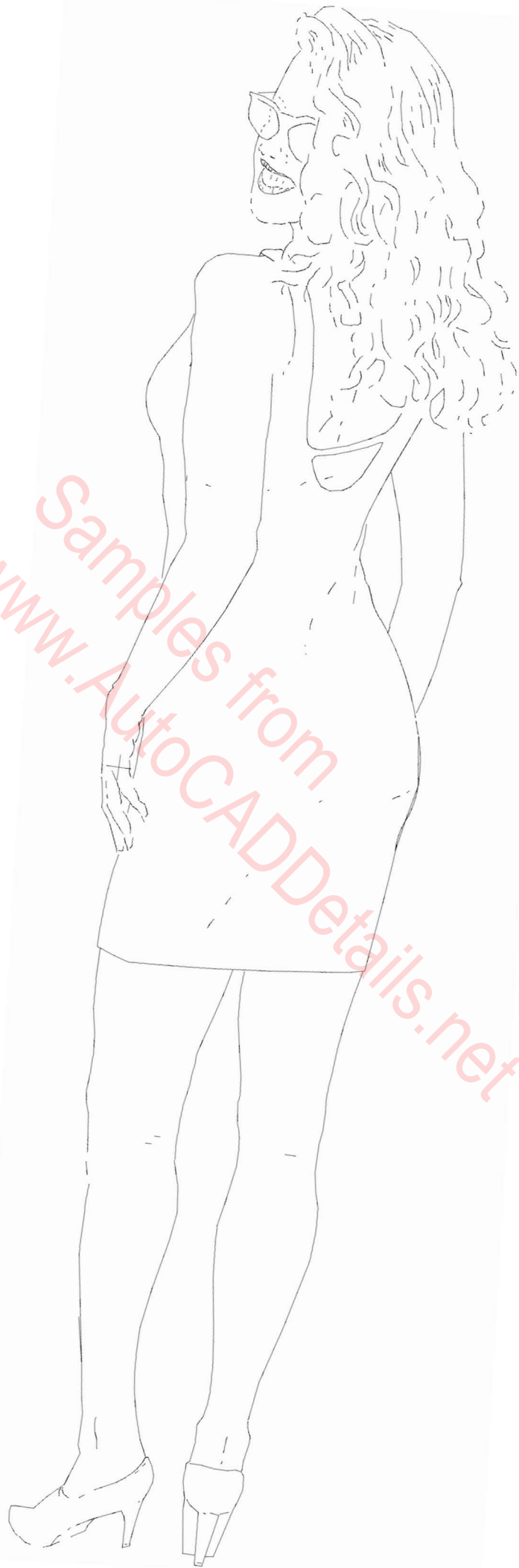



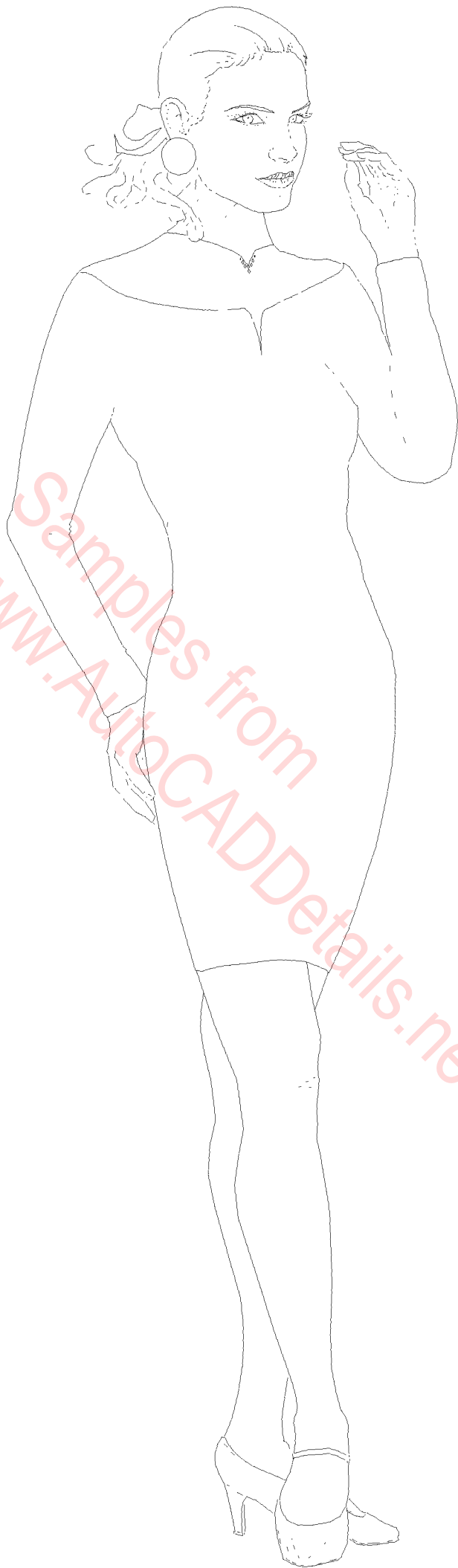

Samples from
www.AutoCADDetails.net

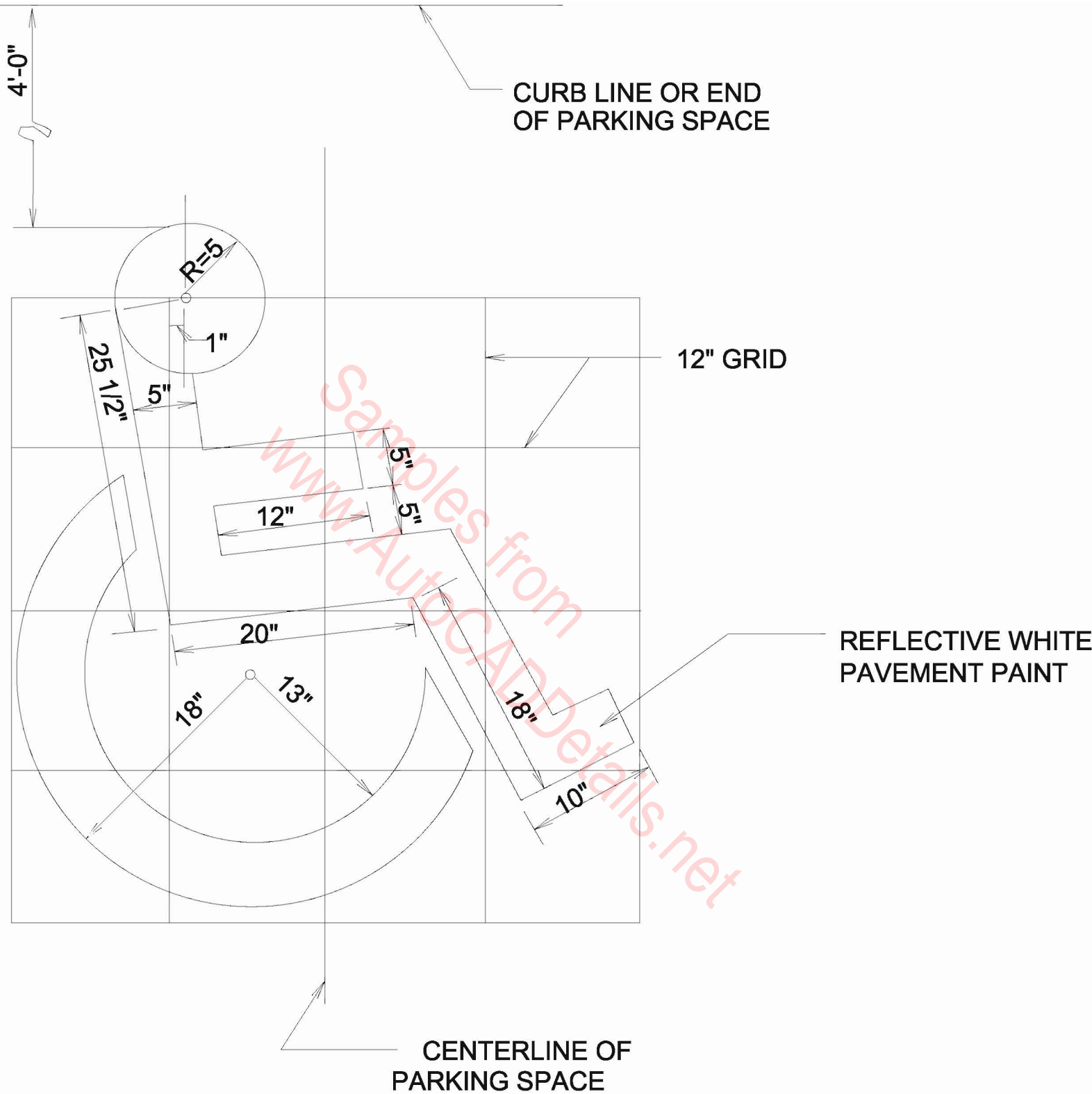

HANDICAP PARKING SYMBOL

N.T.S.

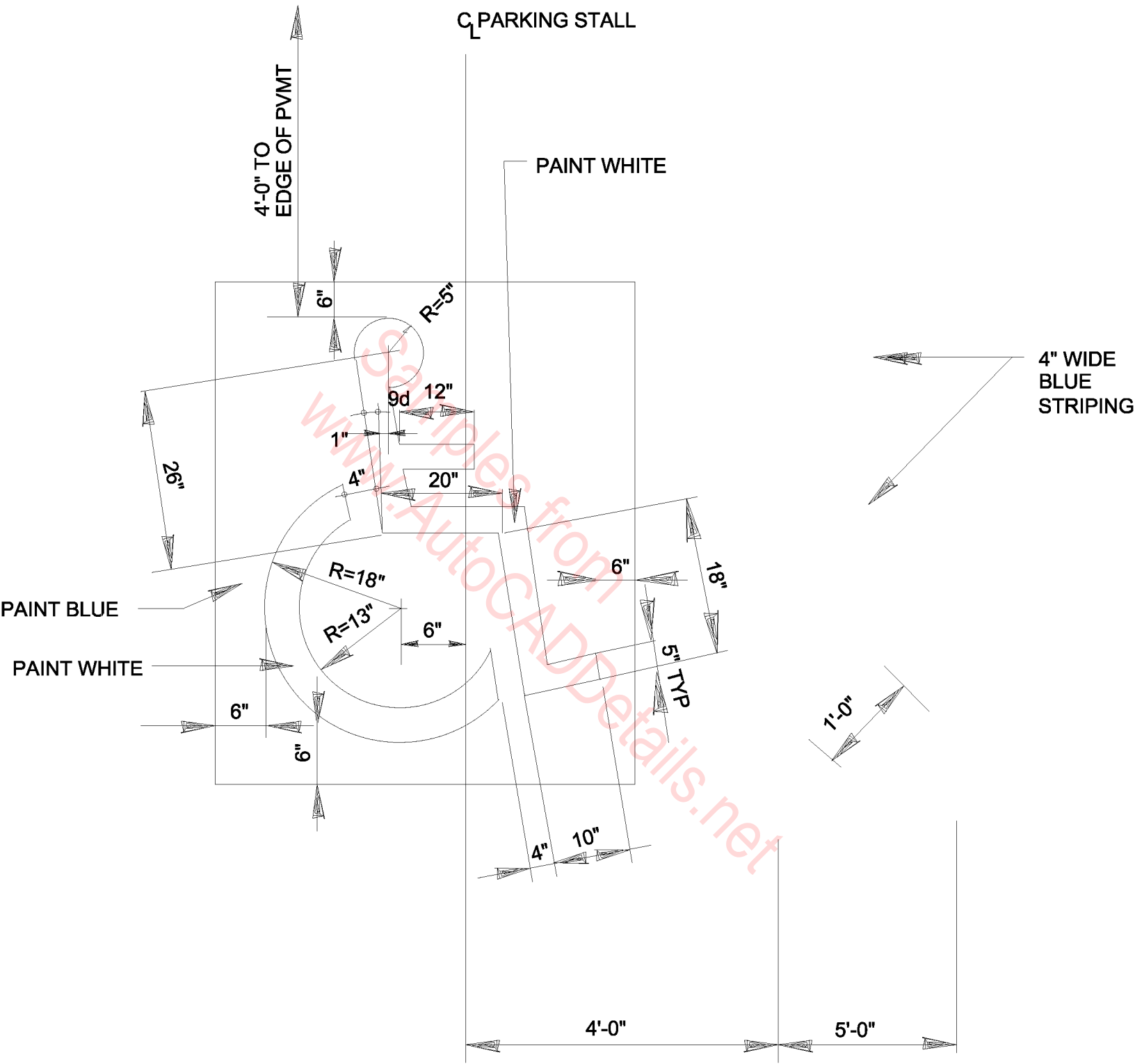

HANDICAPPED PARKING DETAIL

N.T.S.

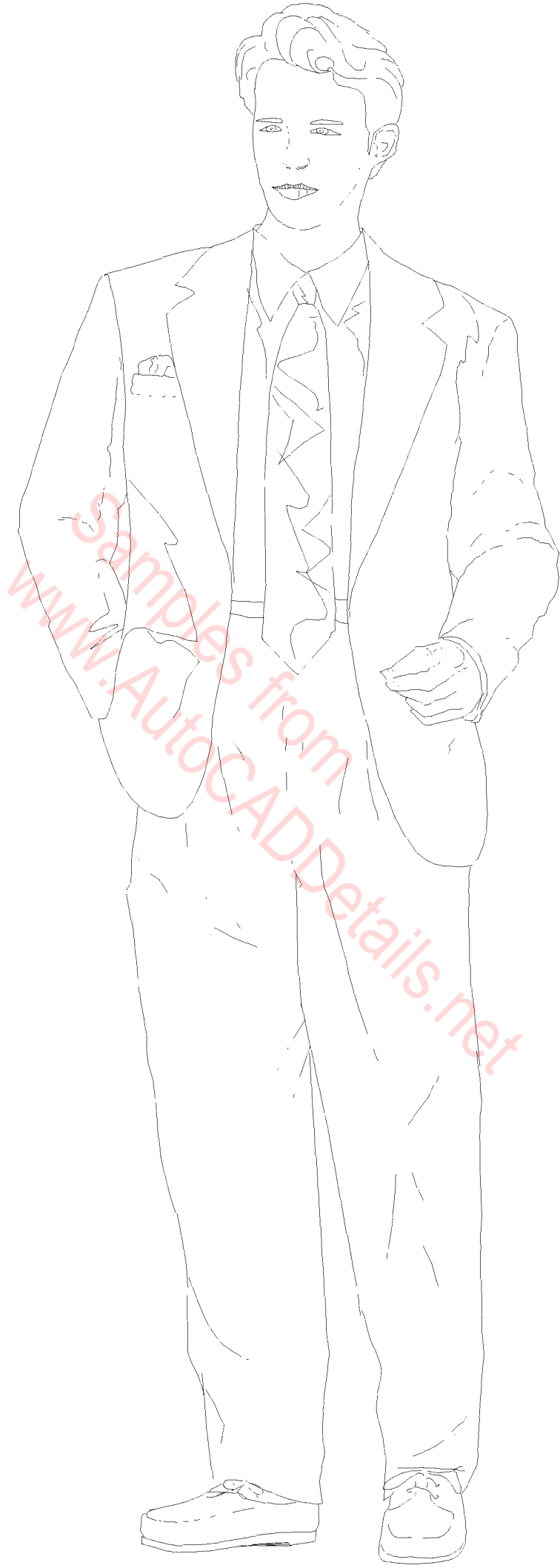

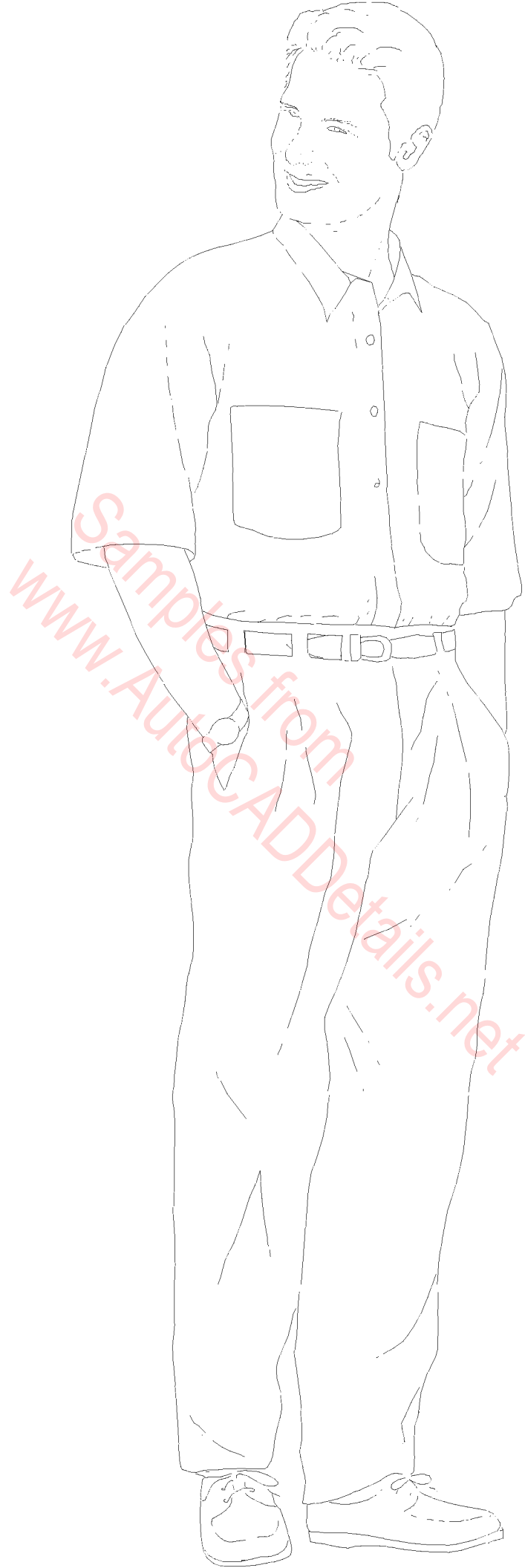

Samples from
www.AutoCADDetails.net

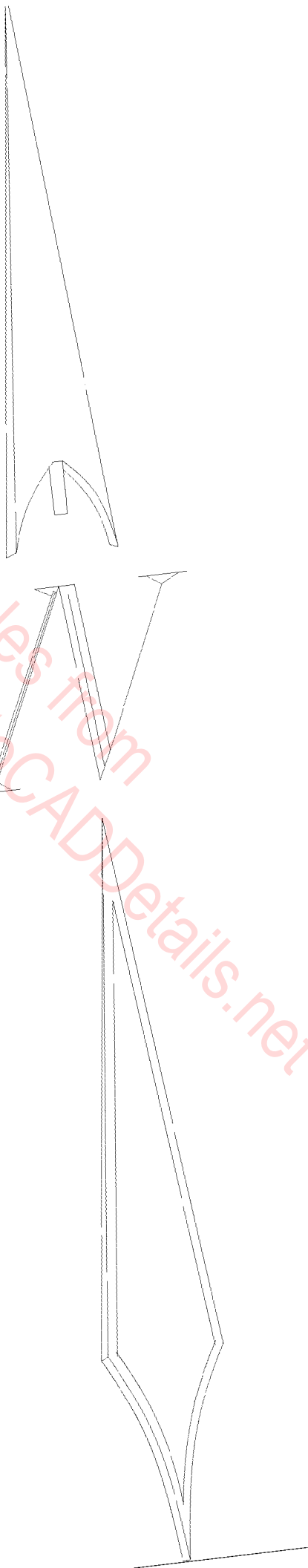

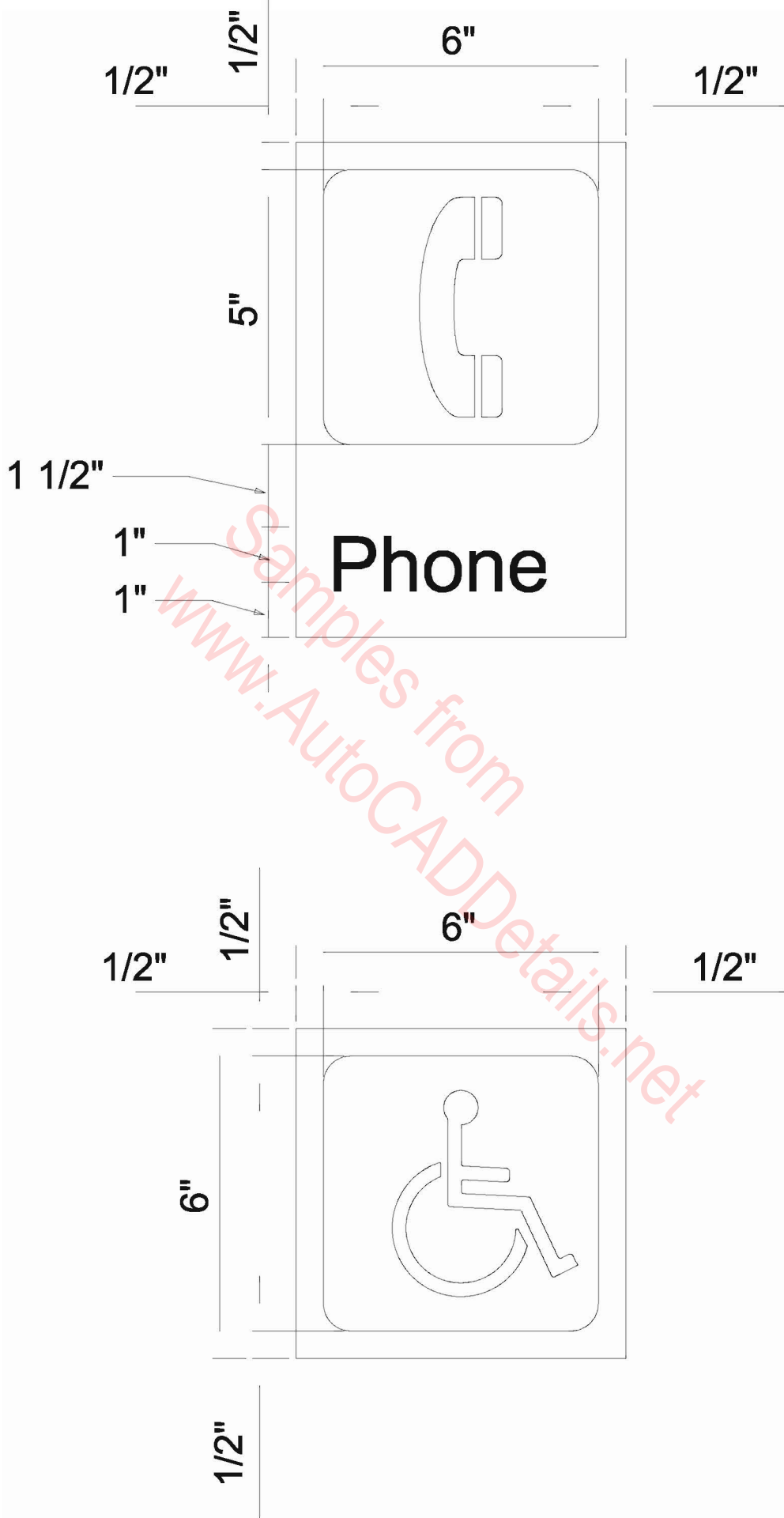

PHONE/HANDICAP SIGN

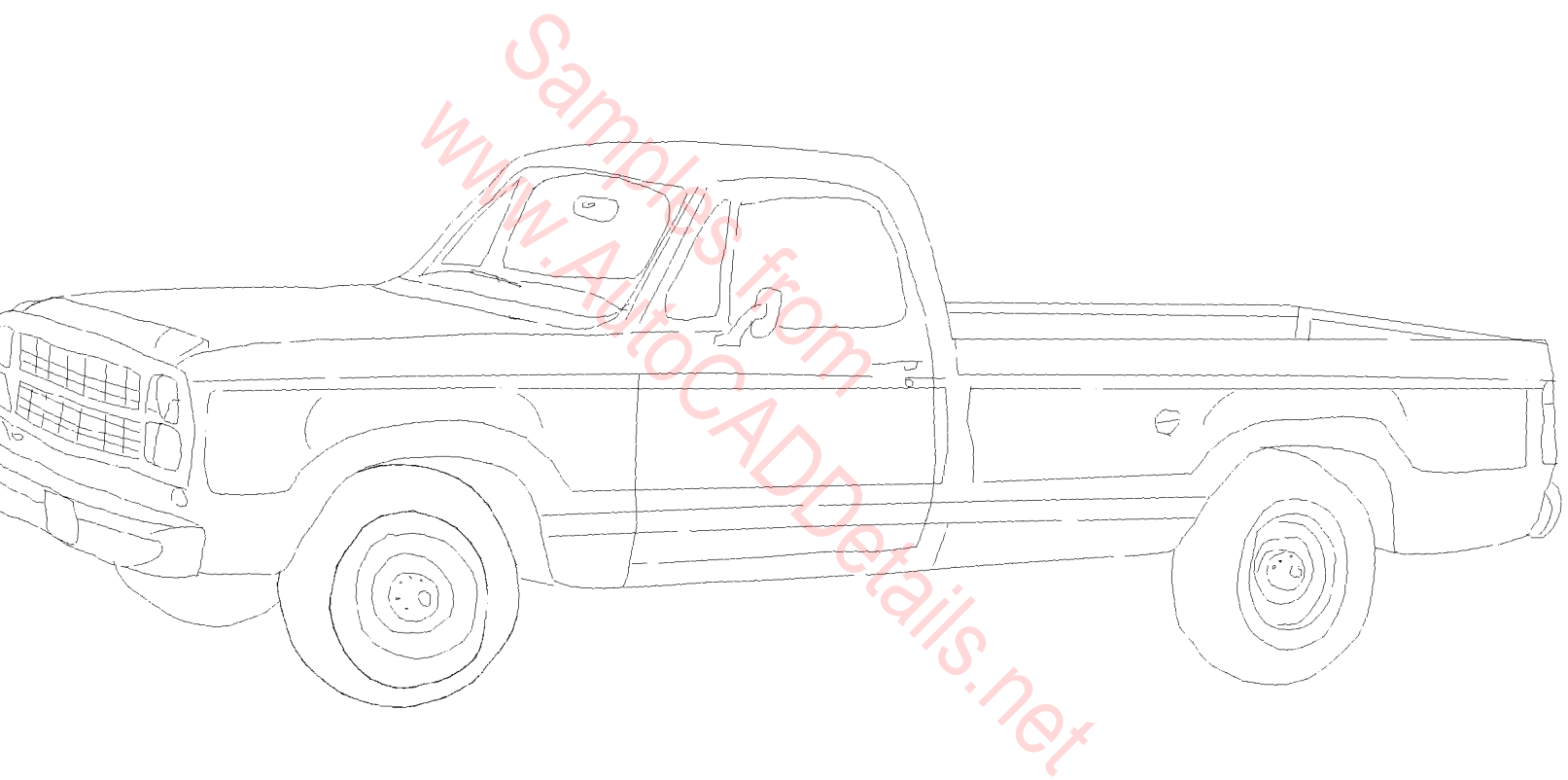

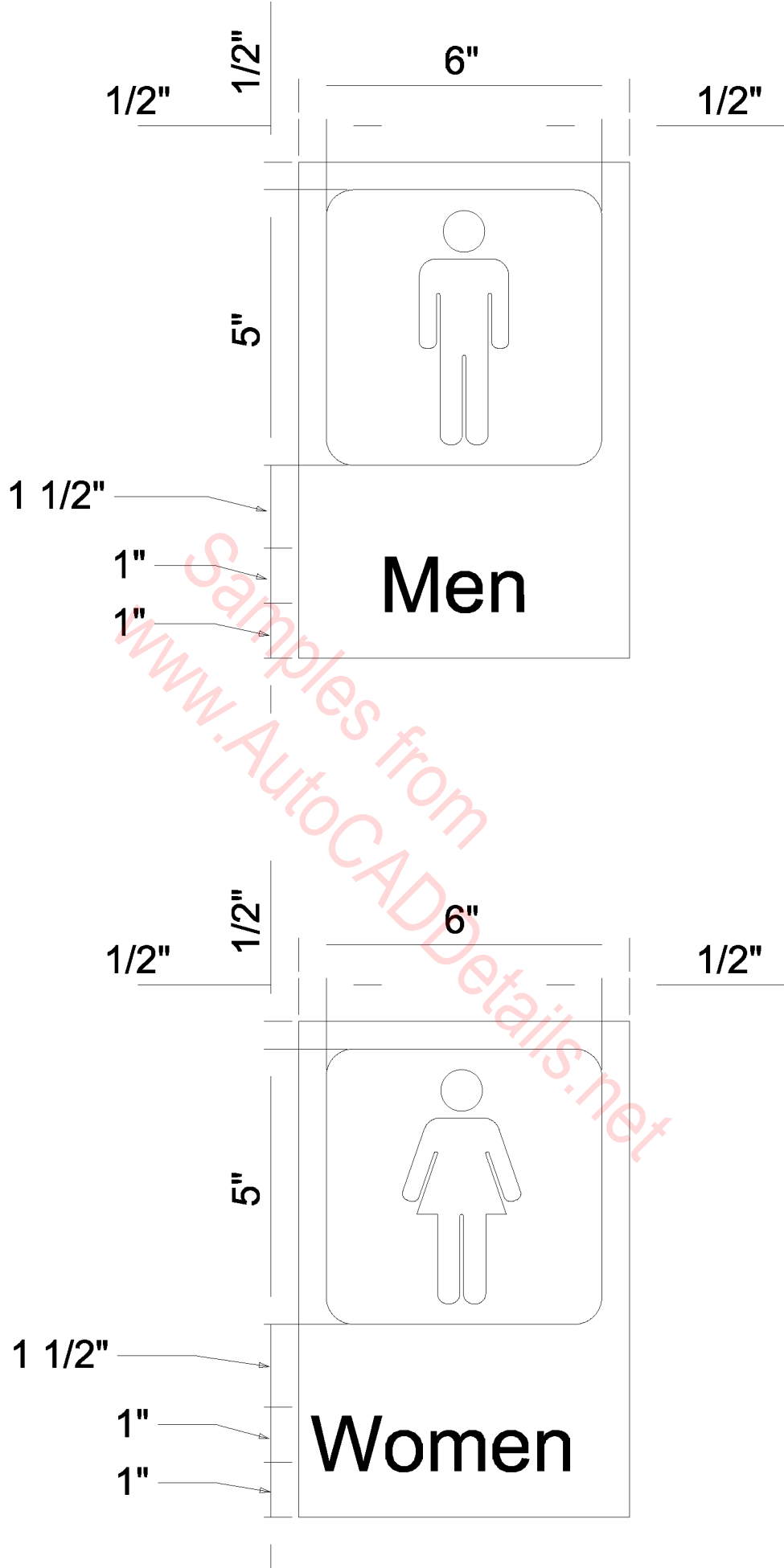

REST ROOM SIGNS

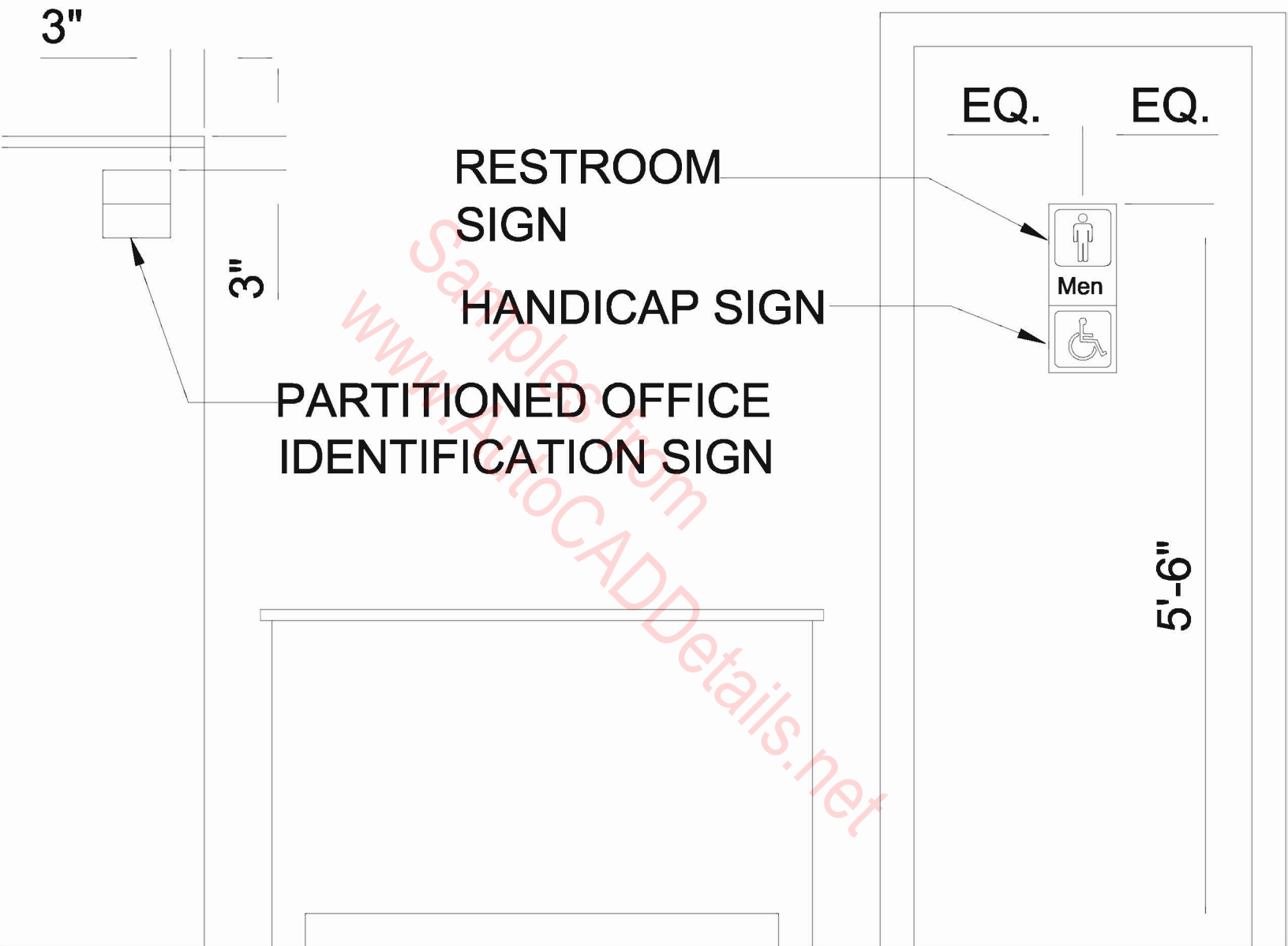

SIGNAGE MOUNTING HEIGHTS

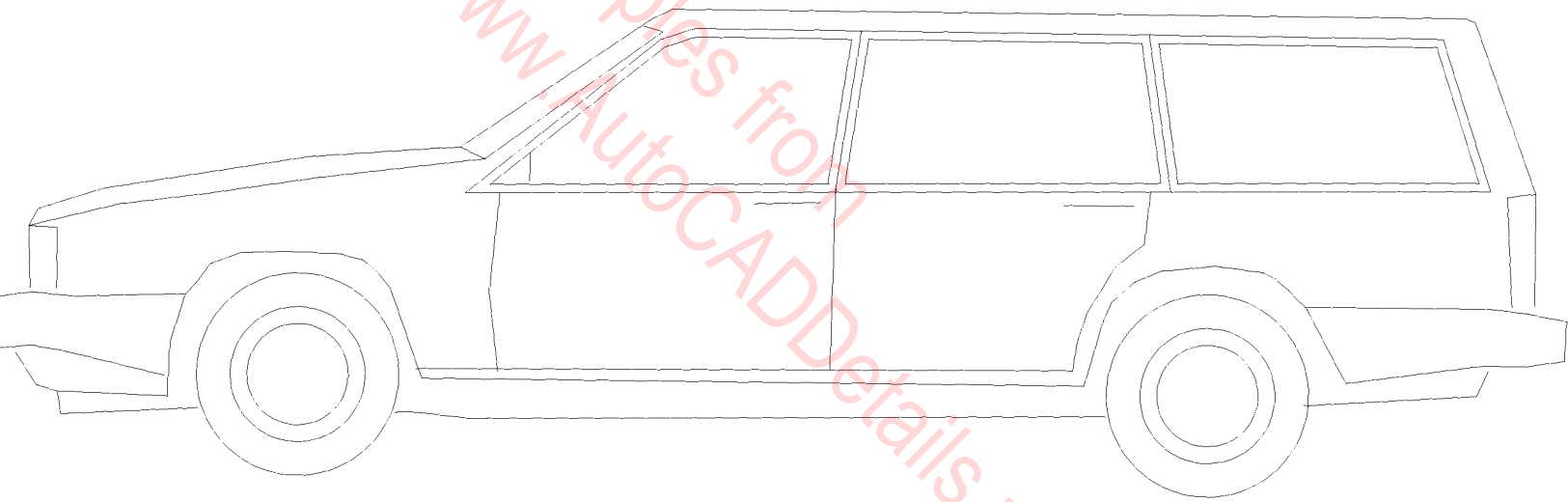

Samples from
www.AutoCADDetails.net

2" WD. SCREWS @
2 X 4 WD. BLOCKING
CONT. BETWEEN 3 5/8"
MTL. STUDS @ 16" O.C.

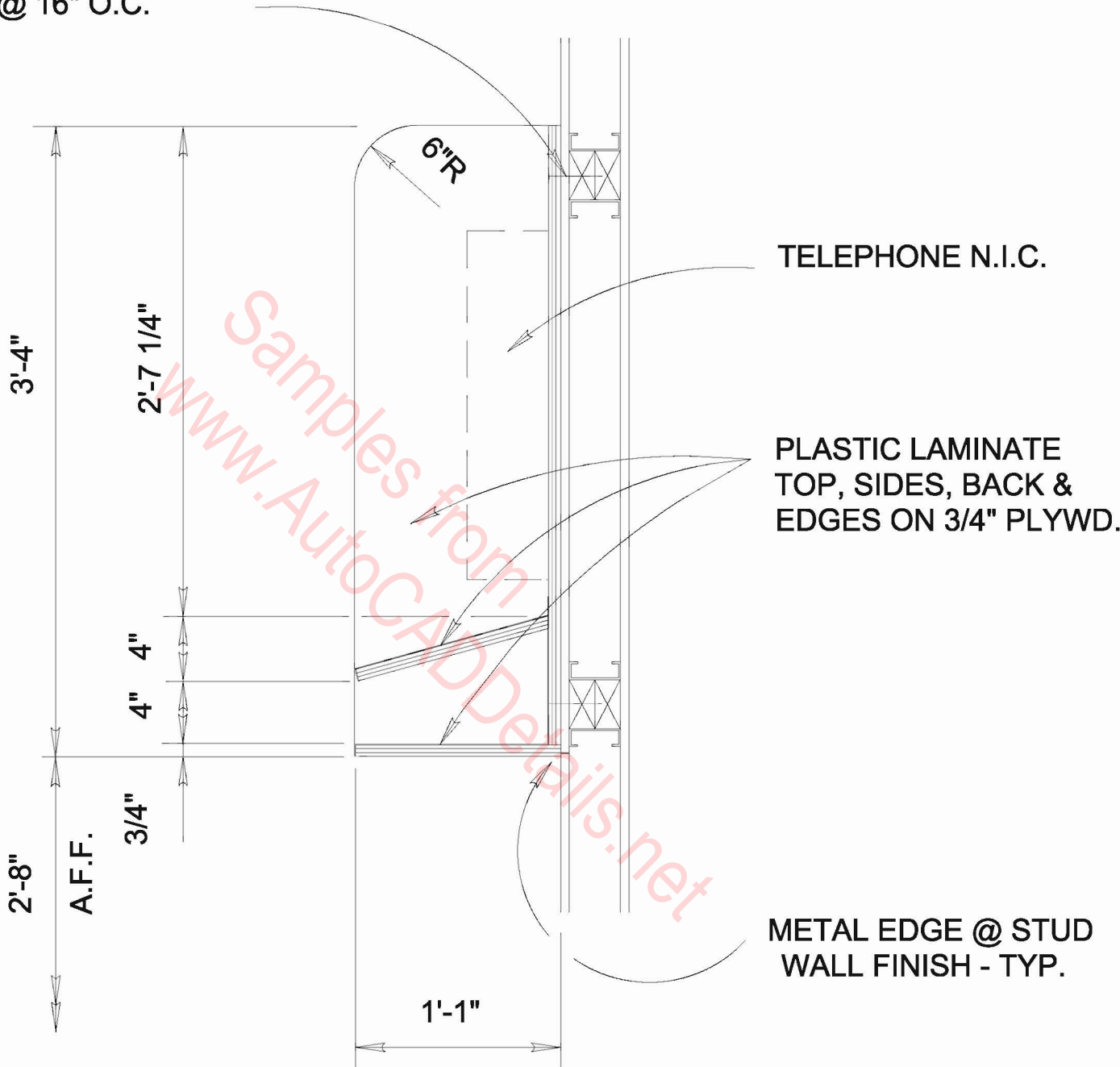

NOTE:
CONTRACTOR MAY CHOOSE TO
PURCHASE A PRE-ASSEMBLED
UNIT FROM AREA PHONE COM-
PANY, SIMILAR TO THAT REP-
RESENTED HERE.